

A200 Analog

► INSTALLATION MANUAL



Thank you for purchasing the Sangoma A200 card!
Please follow these instructions to begin using your new card.

▶ 1. INSTALL YOUR PBX SOFTWARE

Install your choice of supported software.

(e.g., Asterisk®, FreeSWITCH, Yate, CallWeaver, etc.)

See the list of compatible software at:

http://www.sangoma.com/products_and_solutions/compatible_software

▶ 2. INSTALL YOUR HARDWARE

A) Ensure you are grounded.

(i.e., Touch unpainted metal to avoid destroying a computer with electrostatic discharge, work on non-carpeted areas, etc.)

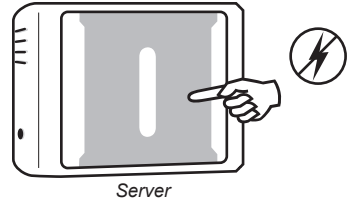

B) Carefully remove card and components from packaging.

Additional cards and components may be purchased separately.

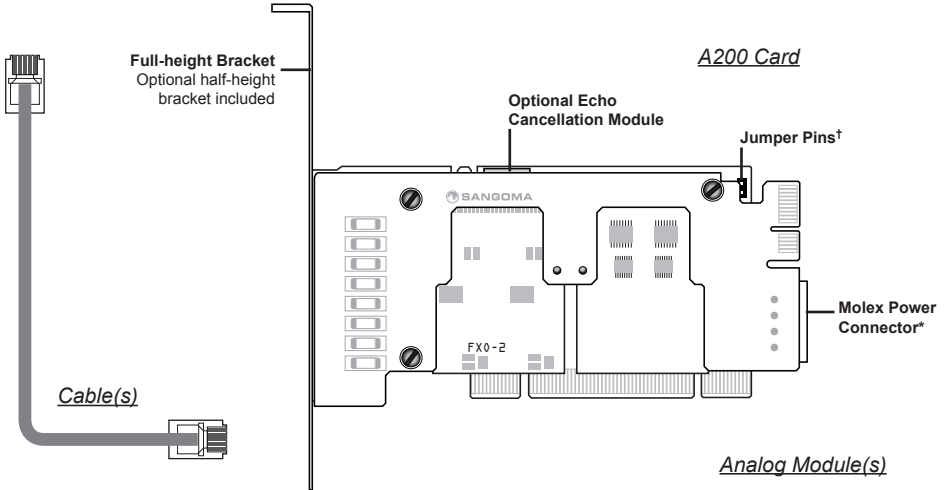

* If using one or more Remora daughter cards, you must attach a Molex Power Connector from your computer's power supply unit to the A200 main card.

When using FXS, you must always attach a Molex Power Connector from your computer's power supply unit, even for a small system with no Remora. This is also recommended when using FXO on a small system, but it is not necessary.

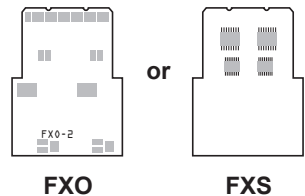

C) Insert the card into an open PCI or PCIe slot in server.

Fasten PCI bracket to chassis.

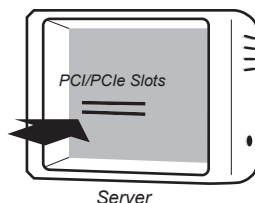

▶ 3. INSTALL THE DRIVERS (WANPIPE® CD)

Visit wiki.sangoma.com for the latest drivers and instructions.

You're done! Enjoy your new card.

▶ SYNCHRONIZE FOR FAX (PATENT PENDING)

Your A200 Card is fax synchronization ready.

Fax machines, connected to a PBX using PRI or BRI connection, run inconsistently at best, simply because the analog interface supporting the fax machine is not synchronized to the PSTN timing. Lack of a properly synchronized connection can result in faxes that are distorted, missing lines and even fail outright.

To synchronize your new A200 to your digital card (A100-series or A500) simply connect the jumper pins† on both cards via a two-wire jumper cable (each sold separately).

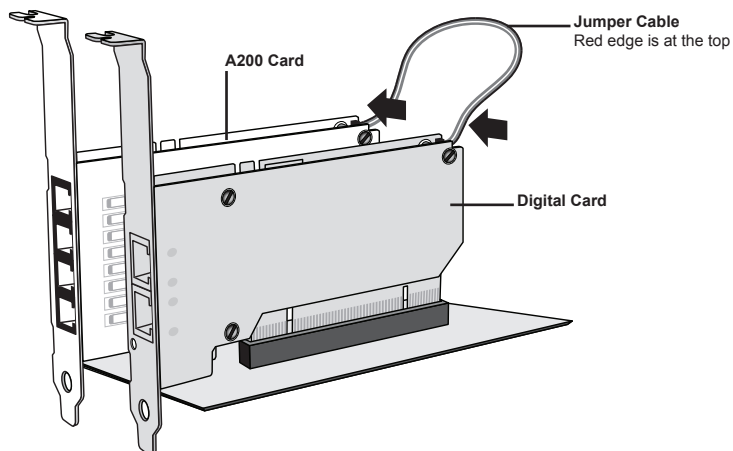

The digital card must have a HWEC (hardware echo canceller).

The minimum firmware that supports clock synchronization for the A200 is v10.

For more information, please go to wiki.sangoma.com/t1e1analogfaxing

See diagram for corresponding ports and module slots.

e.g.
The module inserted at Slot A corresponds to Ports 1 and 2.

The module inserted at Slot B corresponds to Ports 3 and 4.

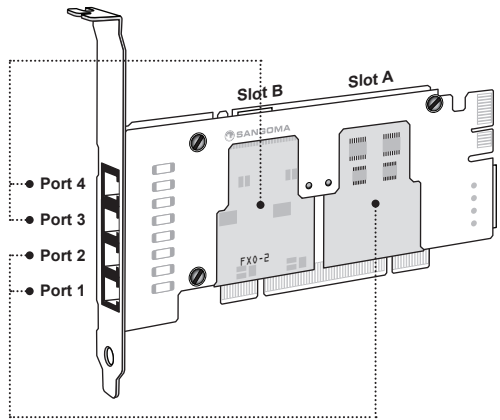

► OPTIONAL – INSTALL UP TO 6 REMORA™ EXPANSION CARDS

Attach additional Remora card(s) using a backplane.

It is ideal to put the Remora(s) to the right of the main card, so that the main card always contains port 1. However, if space is a concern, either side is appropriate.

The lowest number port on the backplane corresponds to port number 1 in the stack. (e.g., JP6 on a 4-connector backplane.)

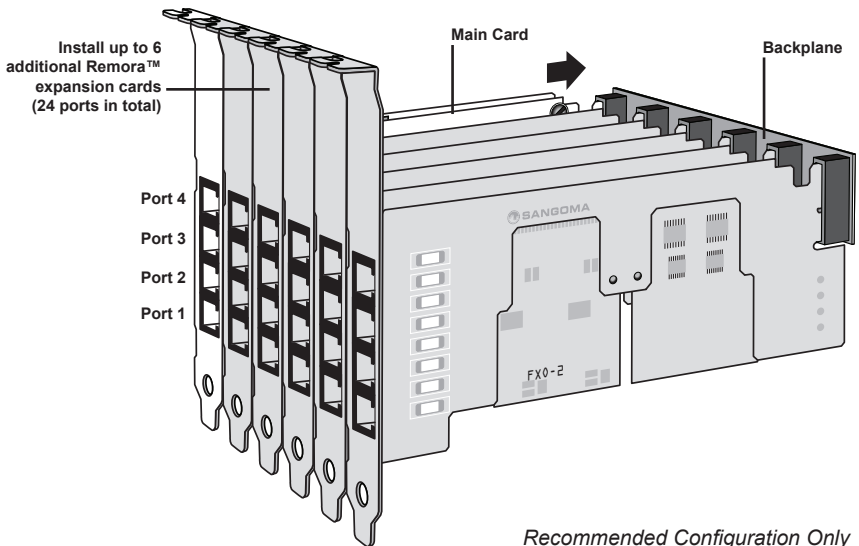

Recommended Configuration Only

► BOOT CARD WITH FIRMWARE RECOVERY JUMPER SET

All A-Series cards contain Crash-proof Field Upgradable Firmware. This means your A200 card has TWO (2) Firmware flash devices.

During card flashing, the new firmware is stored into the primary flash device. If the machine crashes during card flashing and causes the primary flash device to become corrupted, the secondary flash device can be selected to boot the card. This will allow you to re-flash the primary device again.

In order to select the secondary flash device:

1. Shut down the machine and take out the A200 card.
2. Enter firmware recovery mode by connecting the two jumper pins[†] on the upper rear of the card.
3. Restart the machine with firmware recovery jumper set.
4. Proceed to re-flash the card.
5. Once re-flashing is completed, shut down the machine and remove jumper.
6. Restart the machine with new card firmware.

If you are unsure of how to upgrade your firmware/flash your card, detailed instructions are provided on wiki.sangoma.com.

► LIFETIME WARRANTY

New Sangoma A-Series hardware comes with a lifetime warranty for replacement and repair from the date of purchase.

This includes a no-questions-asked 30-day money back guarantee, Sangoma's renowned free technical support, and free replacement in the unlikely event of a defect.

IMPORTANT – To qualify for the lifetime warranty, the end user must:

- Register this product online at: <http://www.sangoma.com/warranty/register/>
- Be able to prove point of purchase. To qualify for Lifetime Warranty protection, the product must have been purchased from an Empowered by Sangoma partner.



CONTACT US

INTERNATIONAL	+1 905 474 1990	EMAIL	techdesk@sangoma.com
TOLL FREE IN N. AMERICA	1 800 388 2475	WIKI	wiki.sangoma.com

Let us know whether this manual was helpful – your feedback is appreciated!