



Grandstream Networks, Inc.

GXV3662 User Manual

Safety Instructions

These instructions are intended to assist users with the operation of the GXV3662 and also to instruct on how to avoid dangerous situations or damage to the device.

Warnings: Serious injury or death may be caused if any of the warnings below are neglected.

Cautions: Injury or damage to the equipment may occur if any of the following caution messages are neglected.



Warnings Follow these safeguards to prevent serious injury or death.



Cautions Follow these precautions to prevent potential injury or material damage.



Warnings:

Input voltage should meet both the SELV (Safety Extra Low Voltage) and the Limited Power Source with DC 12V according to the IEC60950-1 standard. Please refer to the technical specifications for more details.

Do not use a third-party power adapter or power cord

When the device is installed on the wall or ceiling, make sure that it is firmly attached.



Notice:

Make sure that the power supply voltage is correct before using the camera.

Do not drop the device or expose it to physical shock.

Do not expose the device to temperatures outside the range of -30 °C to +50 °C PSU and PoE mode when the device is in operation.

Do not expose the device to high electromagnetism radiation.

To avoid heat accumulation, make sure that your operating environment has proper ventilation.

Do not attempt to open, disassemble, or modify the device

A few parts (e.g. electrolytic capacitor) of the equipment shall be replaced regularly according to their average life time. The average life time varies from the differences between operating environments and usage history. Regular maintenance checks are recommended for all users. Please contact your dealer for more details.

Note:

This device complies with part 15 of the FCC Rules. Operation is subject to the following two conditions:

- (1) This device may not cause harmful interference, and
- (2) This device must accept any interference received, including interference that may cause undesired operation.

Changes or modifications not expressly approved by the party responsible for compliance could void the user's authority to operate the equipment.

Note: This equipment has been tested and found to comply with the limits for a Class B digital device, pursuant to part 15 of the FCC Rules. These limits are designed to provide reasonable protection against harmful interference in a residential installation. This equipment generates uses and can radiate radio frequency energy and, if not installed and used in accordance with the instructions, may cause harmful interference to radio communications. However, there is no guarantee that interference will not occur in a particular installation. If this equipment does cause harmful interference to radio or television reception, which can be determined by turning the equipment off and on, the user is encouraged to try to correct the interference by one or more of the following measures:

- Reorient or relocate the receiving antenna.
- Increase the separation between the equipment and receiver.
- Connect the equipment into an outlet on a circuit different from that to which the receiver is connected.
- Consult the dealer or an experienced radio/TV technician for help.

Contents

Welcome	5
Package Contents	6
Product Overview	7
GXV3662 Top View	7
GXV3662 Side View	7
GXV3662 Bottom View	7
GXV3662 Inside connections	8
GXV3662 Sample Connection Diagram.....	10
GXV3662 Key Features.....	10
GXV3662 Lens Specification	11
Minimum Recommended System Requirement	12
Connect your GXV3662	12
Configuring the GXV3662 via Web Browser.....	13
Access the GXV3662 Web Configuration Menu.....	13
Connect the Camera to a DHCP server.	13
Connect to the Camera Using a Static IP.	14
GXV3662 Home Web Page	15
GXV3662 System Time and Name Page.....	16
GXV-3662 Video & Audio Page.....	17
GXV3662 Networking Page – Assigning an IP to the GXV3662	19
GXV3601 DDNS Page	20
GXV3662 SIP Page	21
GXV3662 Status Page	23
GXV3662 User Management Page.....	24
GXV3662 Maintenance Page	24
GXV3662 SMTP Page.....	25
GXV3662 FTP Page	26
GXV3662 Alarm Event.....	26
GXV3662 Motion Detection Page.....	29
Configure Motion Detection & Alarm Actions	30
GXV3662 System Log.....	31
FAQ.....	32

Welcome

The GXV3662 is a next generation IP camera for remote monitoring and surveillance over your LAN or internet.

The GXV3662 combines best in class IP video technology and SIP protocols for a robust IP surveillance solution. The product features H.264 video streams with up to 30 frames per second at 720p resolution, delivering rich image clarity at rapid transmission rates. Integrated SIP can pass alarms to the PSTN, mobile phones, SIP IP phones, SIP videophones and enables 2-way VoIP communication.

The GXV3662 ensures ease of use, integration and deployment with a multilingual graphical user interface. The GXV3662 can be quickly installed and connected to your network and accessed from anywhere over the internet. Grandstream's flexible video management software enables users to monitor multiple environments in one easy to use application. The intuitive web interface lets users easily access, manage, view and record live video streams from the device.

The GXV3662 is a powerful solution for small to medium sized offices, homes and storage facilities looking to safeguard their valuables.

Package Contents

Items in the package:

- GXV3662 IP Camera
- 12V DC power Adapter attached to terminal block
- 8-pin terminal block connector – 8-pin connector block for connecting external devices, such as infrared detector, smoke detector, emergency lights, etc., to Alarm IN and Alarm OUT. You can also connect microphones and powered speakers through the audio in and audio out ports.
- Quick installation guide
- Alignment sticker
- Tool set containing a hex key, 3 plastic anchors and 3 screws

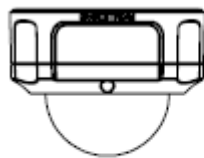

GXV3662



POWER ADAPTER



TOOL SET

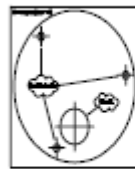

ALIGNMENT STICKER

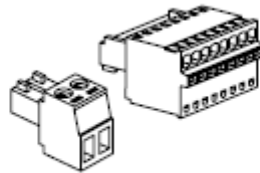

TERMINAL BLOCK



QUICKSTART GUIDE

Product Overview

GXV3662 Top View



GXV3662 Side View

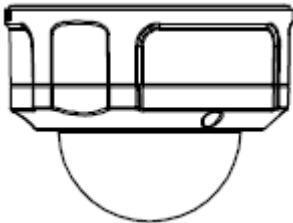

GXV3662 Bottom View

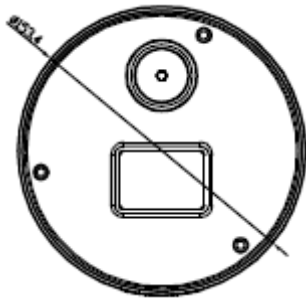

GXV3662 Inside connections

Indicators and Connectors inside the camera

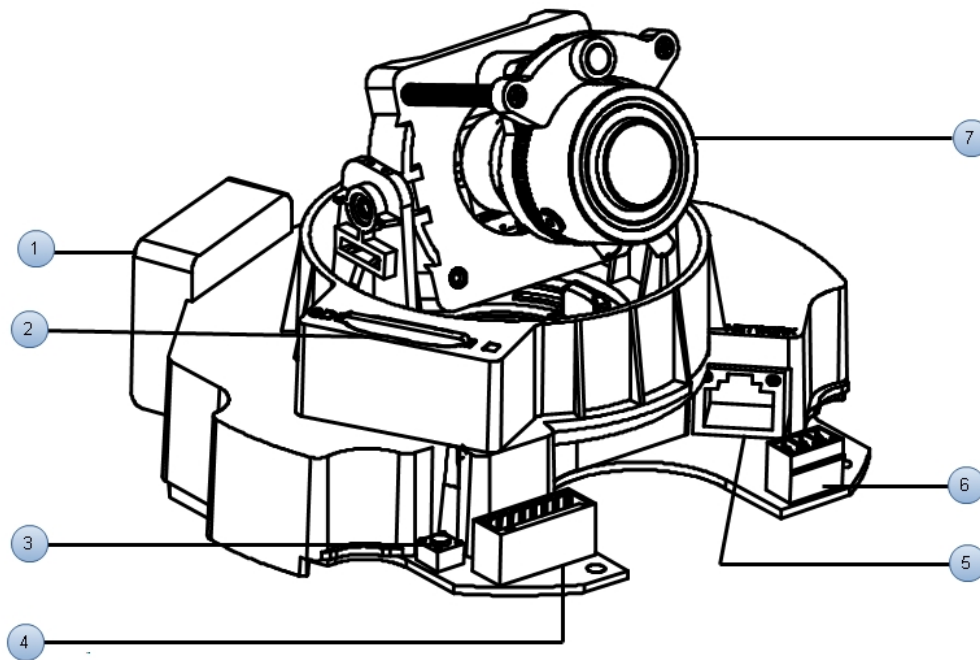

- | | | |
|----------|--|---|
| 1 | <i>Internal temperature regulator</i> | It adjusts the temperature to ensure the camera works normal under different weather. |
| 2 | <i>SD card slot</i> | SD card slot. |
| 3 | <i>Reset</i> | Press the Reset button for 6 seconds to perform a factory reset. |

4 Alarm/Audio

NOTE: GXV3662 does not support zoom

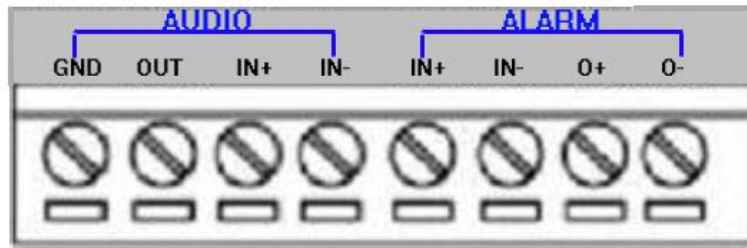

Type	Port	Description
AUDIO	GND	Audio Output
	OUT	
	IN+	Audio Input
	IN-	
ALARM	IN+	Alarm Input
	IN-	
	O+	Alarm Output
	O-	

5 Network

10/100 Switch LAN port for connecting to Ethernet. The indicator will be steady for connection and flashing for network activity.

6 Power



Type	Description
12V	12 V DC input
GND	Ground

7 Lens

For adjusting the lens, unscrew the housing and adjust the lens vertically/horizontally. Screw the housing back when adjustment is done.

Note: Loosening the screws on both sides of axle might be necessary for adjusting the lens vertically.

GXV3662 Sample Connection Diagram

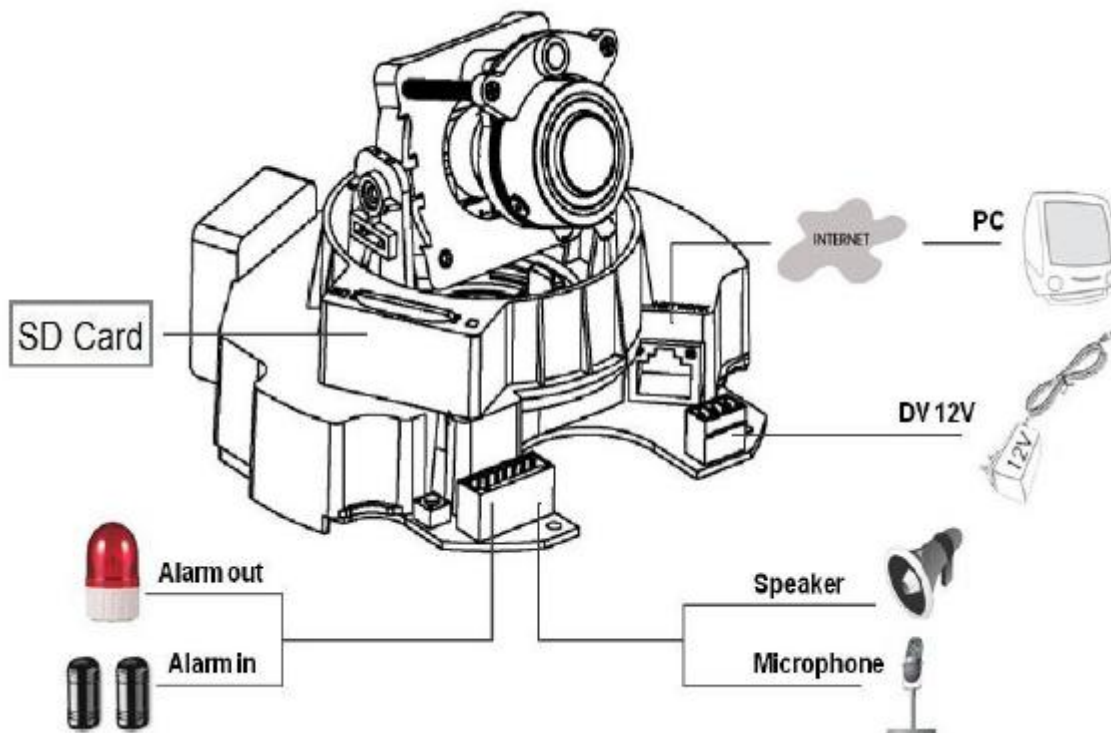

GXV3662 Key Features

The table below lists the key features the GXV3662 Supports.

Features	GXV3662
Image Sensor	1/3", 1.2 Megapixel CMOS, 1280H x 960V, day and night mode, exceptionally low noise levels and low light sensitivity. Shutter time: 1/30 to 1/1000 seconds
Lens Type	1/3", 3.3-12mm, F1.6-F3.2 (F1.4-F2.9), DC-Iris, Manual focus: 50cm - ∞, H: 89.8° - 23.9°, V: 63.6° - 17.9°
Day & Night	YES, CDS Sensor, mechanical IR Cut filter
Minimum Illumination	0.05 lux
Responsivity	6.0V/lux-sec (550nm)
Max Frame Rate	1280 x960 @ 30fps
Pixel Dynamic Range	Wide Dynamic Range of 120dB with SNR _{MAX} 44dB
Supported Video Resolutions	30fps for 1280x960, 1280x720, 1024x768, 800x592, 800x480, 640x480, 640x368, 480x368, 480x272, 320x240, 320x176, 256x192 and 256x144 all at 30 fps
Video Bit Rate	64 Kbps – 8 Mbps, multi rate for preview and recording
Audio Input	LINE-IN
Audio Output	LINE-OUT
Alarm Input	V _{IN} ≤45V, I _{IN} ≤35mA

Alarm Output	125VAC/0.5A, 30VDC/2A, Normal Open
Audio Compression	G.711a/u
Serial Ports	N/A
IRIS Control	DC-IRIS
Embedded Analytics	Motion detection (up to 16 target areas), video loss (pending)
Pre-/post-alarm Buffer	24MB
Snapshots	Triggered upon events, send via email/FTP
Multi-streaming-rate for Preview & Recording	Yes
Security	Video watermark (pending), HTTPS, admin/anonymous
Network Port	10M/100M auto-sensing, RJ45
Network Protocol	TCP/UDP/IP, RTP/RTCP, RTSP, DHCP, DDNS, HTTP, HTTPS, SMTP, FTP, NTP
Power over Ethernet (PoE)	IEEE 802.3af default class
Peripheral Ports	Internal SDHC 2.0 socket
SIP/VoIP Support	Yes
Dimensions (D x H)	153mm x 115mm
Weight	1.19kg
Temperature / Humidity	-30C - +50C (-22F- +122F) for DC and PoE, With heater & fan Humidity 10-90% RH(non-condensing)
Power Adapter	Output: 12VDC/1A; Input: 100–240VAC, 50–60Hz
Casing	Vandal proof and weatherproof with IP66 standard
Compliance	FCC, CE, C-tick, IP66

GXV3662 Lens Specification

Parameters	GXV3662
Lens Format	1/3"
Image Sensor	1/3" CMOS
Focal Length	3.3mm – 12mm
Aperture Ratio	F1.6 – F3.2
View Angle	D:125.7°- 29.9° H: 89.8°-23.9° V: 63.6°-17.9°
IRIS	DC AUTO
Minimum Object Distance	50 cm
IR CUT Filter	Yes

Minimum Recommended System Requirement

- Windows 2000 Server Professional, Windows XP, Windows Vista.
- CPU: Intel Pentium 4 or higher, 2 GHz.
- RAM: 1 GB (4 GB recommended for larger systems).
- Support for DirectX 8.0 and above.

Connect your GXV3662

Using the Power adapter as power supply

- Connect an RJ-45 cable to the NETWORK port of the GXV3662.
- Connect the other end of the RJ-45 cable to your network or PC.
- Connect the power supply to the DC 12V connector block inside the GXV3662.
- Connect the other end of the power supply to a wall outlet. The POWER LED will turn solid green.

Using PoE as power supply:

- Connect an RJ-45 to the NETWORK port of the GXV3662.
- Connect the other end of the RJ-45 cable to a PoE switch. The POWER indicator will turn solid green.

NOTE: If you are going to connect the device to a hub/switch/router, please use a straight-through cable. A crossover cable should be used if you are going to connect the device directly to a PC.

Connect to the Camera Using a Static IP.

If the camera does not get a response from the DHCP server after 3 minutes, it can be accessed by the default IP 192.168.1.168.

1. Connect your PC to the same network as the GXV3662.
2. Configure the IP address of your PC to: 192.168.1.XXX (1<XXX<255) and configure the subnet mask to 255.255.255.0.
3. Make sure that the device is turned on and connected to the network.
4. Start Internet Explorer on your computer.
5. Enter 192.168.1.168 in the address bar of the browser.
6. Enter the administrator user name and password to access the Web Configuration Interface
7. The default user name and password are both set to admin.
8. IE will indicate that "This website wants to install the following add-on: 'GSViewerX.cab' from 'Grandstream Networks Inc'." Install this add-on by following the instructions in IE.
9. You will see the home page.

GXV3662 Home Web Page

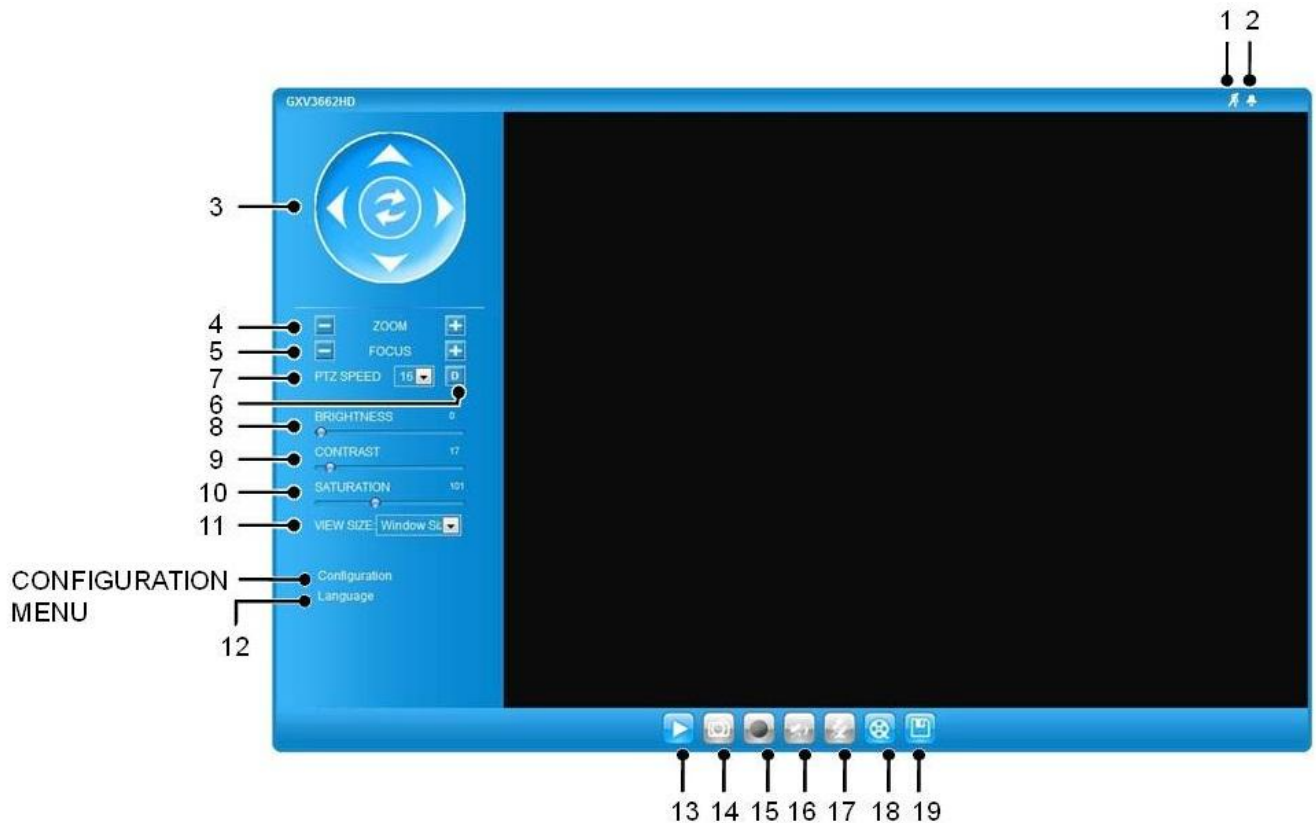

Figure 2: Home web page of GXV3662-HD

Items on GXV3662 Home Page

- | | | |
|-----------|-------------------------|---|
| 1 | Motion Detection | If the motion detection alarm is triggered, the indicator will flash red . Click on the indicator to turn off the alarm. |
| 2 | Alarm Event | If an alarm event is triggered, the indicator will flash red . Click on the indicator to turn off the alarm. |
| 3 | Control Console | PTZ Console controller. PTZ is not supported in the GXV3662 |
| 4 | ZOOM | NOTE: The GXV3662 does not support zoom |
| 5 | FOCUS | Adjusts the focus of images. |
| 6 | Default | Click this option to reset the video brightness, contrast, and saturation to their factory default configuration. |
| 7 | SPEED | Adjusts the rotation speed of the console. |
| 8 | BRIGHTNESS | Adjusts the image brightness. |
| 9 | CONTRAST | Adjusts the image contrast. |
| 10 | SATURATION | Adjusts the image saturation. |
| 11 | View Size | Resize the image to fit into the window panel in the home screen. |
| 12 | Language | Chose between English and Chinese |

- 13 Play** Displays the video in the main frame
- 14 Capture** Captures the image displayed and saves it to **C:\IGS_Capture** (default directory).
- 15 Record** Records the video and saves it to **C:\IGS_Record** (default directory).
- 16 Sound Off/On** Toggles the sound On or Off.
- 17 Talk** Establishes two-way audio.
- 18 Playback** Replays the saved video.
- 19 Config** Configures the Save Location for captured images and recorded videos.

GXV3662 System Time and Name Page

This page allows you to configure the system settings on the GXV3662.

Current System Time - displays the current date and time (24h clock).

Current System Time

Date:

Time:

Set the System Time

Update via NTP Server

- the camera will obtain the time from an NTP server, specify the NTP server's IP address or host name. And you can select your time zone

Set the System Time

Time Zone:

Update via NTP Server
 Synchronize with Local Computer
 Set the Time Manually
 Keep Current Date and Time

from the drop-down list or define your own time zone setting.

NOTE: If using a host name for the NTP server, a DNS server must be configured under **Basic Settings -> Networking**.

Synchronize with Local Computer - sets the time from the clock on your computer.

Set the Time Manually - this option allows you to manually set the time and date.

OSD Date Format - set the format of the date on OSD

OSD Date Format

OSD Date Format:

Device Name Setting -This field lets you configure the name of the GXV3662, which helps

Device Name Setting

Device Name:

GSurf and GS_NVR to identify the device when using **GS_Search** to search all the Grandstream network cameras or digital video cameras in the same subnet.

GXV-3662 CMOS Settings Page

Flip:	<input type="checkbox"/>
Iris Setting:	DC Auto ▼
Shutter Speed:	Auto ▼
IR CUT Setting:	Automatic ▼
IR CUT Sensitivity:	1 ▼
Color Model:	Color ▼

Flip – Enable this option to flip the image 180 degrees

Iris Setting – Select from either automatic, where the iris would open or close depending on the environment conditions, or set it to manual where the user can select from having it open 100/80/60/40/20 percent

Shutter Speed – Select from either automatic shutter speed depending on the environment conditions, or select one of the available shutter speeds from 1/30 to 1/1000th of a second.

IR CUT Setting – Select from either manual or automatic. If the user selects manual then select from either daytime mode or night mode. If the user selects automatic, then select a sensitivity value from 1 to 5 that adjusts the best to the environment conditions.

Color Mode – Select from either color, black and white or automatic

GXV-3662 Video & Audio Page

On Screen Display (OSD) Settings

OSD Time/ Text – The time stamp and channel name displayed on the screen.

– **On Screen Display(OSD)**

OSD Text:	<input type="text"/>
OSD Position:	top ▼
Display Time:	<input checked="" type="checkbox"/>
Display Text:	<input type="checkbox"/>

Video Settings

Preferred Video Codec – The GXV3662 supports the H.264 video codec.

Resolution – The higher the resolution is, the better the video quality is, and higher bandwidth is required.

Low -----> High Resolution
 QCIF CIF 2CIF 720p

Bit Rate – The number of bits that are conveyed or processed per unit of time.

Maximum Frame Rate – The video frame rate is adjustable based on network conditions. *Increasing the frame rate will increase the amount of data significantly therefore consuming more bandwidth.* Video will be impaired due to packet loss when there is insufficient bandwidth.

Bit Rate Control – Variable Bit rate (VBR) and Constant Bit Rate (CBR).

Variable Bit Rate - If VBR is selected, the codec varies the amount of output data per time segment. VBR produces a better quality-to-space ratio. The bits available are used to enable more flexibly and encode sound or video data more accurately, with fewer bits used in less demanding passages and more bits used in difficult-to-encode passages.

Constant Bit Rate - If CBR is selected, the codec's output data is constant regardless of the input data. The output bit rate is defined in "Bit rate". CBR is useful for streaming multimedia content on limited capacity channels. It is easier to calculate required bandwidth as well as the required storage space using CBR.

Image Quality – If 'Bit Rate Control' is set to "VBR", "Image quality" needs to be configured. The better the video quality is, the higher the bit rate will be.

I-frame Interval – While streaming video over a network, compression technologies are used to show the incremental difference between each frame. I-frames are used to help keep the video looking normal. When intervals are shorter, the video quality is higher but uses more bandwidth.

NOTE: The users might need to configure the **Primary Stream** and **Secondary Stream** properly. Sometimes, the user might like to watch the live video stream from the web GUI in low resolution mode while recording a copy via GSurf/GS_NVR in high resolution due to the limitation of internet bandwidth. In this case, for example, primary stream can be configured to have better resolution, and then the users can use primary stream to record while watching secondary video streams.

Video Settings	
Preferred Video Codec:	H264
Resolution:	D1 704*480
Bit Rate:	1024 kbps
Maximum Frame Rate:	30 fps
Bit Rate Control:	<input checked="" type="radio"/> CBR <input type="radio"/> VBR
I-frame Interval:	30 Frame(1-100)

Audio Settings

Preferred Audio Codec – The GXV3662 supports up to 2 different Vocoder types, a-law (PCMA) and u-law (PCMU). The audio can also be turned off by switching the setting to "Disabled"

Audio Settings

Preferred Audio Codec:

Microphone Volume:

Speaker Volume:

Microphone Volume: The user can adjust the volume gain of the microphone on a range from 1 to 5

Speaker Volume: The user can adjust the speaker volume on a range from 0 to 31

Power Frequency - this setting should match the power frequency used in the country to avoid flickering in the image. Users can select between 50Hz indoor, 60Hz indoor and outdoor.

Power Frequency

Power Frequency: Hz

GXV3662 Networking Page – Assigning an IP to the GXV3662

The GXV3662 supports IP version 4. The IP address can be set automatically via DHCP, or a static IP address can be set manually. To make the GXV3662 work properly, the user needs to set the DNS configuration properly. For security purposes, the user can also assign the GXV3662 an HTTP Port other than 80.

IP Address Configuration

The GXV3662 operates in two modes:

Dynamically Assigned via DHCP

– all the field values for the Static IP mode are not used. The GXV3662 acquires its IP address from the first DHCP server it discovers on its LAN.

Statically Configured as –

configure all of the following fields: IP address, Subnet Mask, Default Gateway IP address. These fields

IP Address Configuration

Dynamically Assigned via DHCP

Statically Configured as:

IP Address:

Subnet Mask:

Default Gateway:

are set to zero by default. *Static IP addresses are recommended for the GXV3662*

DNS Configuration

There are two methods of DNS configuration on the GXV3662:

1. The GXV3662 can obtain the DNS server automatically
2. Users can configure their own preferred DNS server

DNS Configuration

Obtain DNS Server Address Automatically

Use the Following DNS Server Address:

Primary DNS Server:

Secondary DNS Server:

HTTP Port

The GXV3662 supports user configured http ports. If the HTTP port is changed, the port number is needed to access the web GUI, for instance: <http://192.168.1.168:8080>.

HTTP

HTTP Port:

NOTE: If the HTTP Port is 80, when you add this device to GSurf or GS_NVR, the RTSP port is 554. If the HTTP Port is changed, when you add this device to GSurf or GS_NVR, please make sure the RTSP port number equals HTTP Port plus 2000.

GXV3601 DDNS Page

Dynamic DNS provides devices that have a variable, often changing IP address with a well known hostname resolvable by network applications through standard DNS queries.

Set up DDNS

1. Apply for a domain name from your service provider.
2. Login to the web configuration page, click **Basic Settings > DDNS**.
3. Enter the required information
 - DDNS Active** – If you want to use DDNS, please set this field to “Enabled” .
 - DDNS ISP Type** – Select your DDNS ISP Type.

Dynamic DNS Settings

DDNS Active:

DDNS ISP Type:

Self-Define DDNS Address:

Site Name:

DDNS Account:

DDNS Password:

STUN Server:

Self-Define DDNS Address – Self-define the DDNS server instead of using DDNS

ISP Type.

Site Name – The DDNS name for your device.

DDNS Account/ DDNS Password – The account and password from the DDNS Provider.

STUN Server – If the device is behind a router, a STUN server is needed to help penetrate the NAT.

4. Click **Save** to save the changes. You might need to reboot the device to apply all the changes.

GXV3662 SIP Page

The GXV3662 has the ability to receive phone calls and make phone calls when an alarm event is triggered through motion detection or alarm input. Register the GXV3662 to a SIP server to enable the device to make and receive phone calls. To make outgoing phone calls, the user needs to configure the **Phone List** properly.

Register the GXV3662 to a SIP Server

1. From the GXV3662 home page, click on **Basic Settings > SIP**.
2. Go to **SIP Settings** Tab.
3. General Phone Settings.

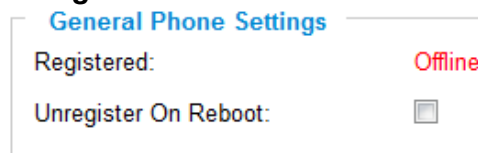

Registered – The field shows the registration status of the account with the SIP server.

Unregister On Reboot – If it's checked, the SIP user's registration information will be cleared from the server when the phone reboots.

4. Enter the required information.

Account Name – The field configures the SIP account name.

SIP Server – The SIP Server's IP address or Domain name provided by your service provider.

Outbound Proxy – The IP address or Domain name of the Outbound Proxy, Media Gateway, or Session Border Controller.

Used for firewall or NAT penetration in different network

environments. If the system detects a symmetric NAT, STUN will not work. ONLY outbound proxies can provide a solution for a symmetric NAT.

SIP User ID – User account information provided by your service provider (ITSP); this is either an actual phone number or extension or is formatted like one.

Authenticate ID – The SIP service subscriber’s Authenticate ID used for authentication. It can be identical to or different from the SIP User ID.

Authenticate Password – The SIP service subscriber’s account password for the GXV to register to the SIP server of the ITSP.

STUN Server – If the device is behind a router, a STUN server is needed to help penetrate the NAT.

Stream – Choose between Primary and Secondary stream resolutions.

Preferred Vocoder – Choose between different Vocoder (codec) type.

Registration Expiration – This parameter allows users to specify the time frequency (in minutes) in which the GXV refreshes its registration with the specified registrar. The default interval is 60 minutes.

Local SIP Port – This parameter defines the local SIP port used to listen and transmit. The default value is 5060.

Local RTP Port – This parameter defines the local RTP-RTCP port pair that is used to listen and transmit. The default value is 5004.

5. Click **Save** to save all the changes. You need to restart the device to apply all changes.

Configure the *Phone List* Page

To make sure the GXV3662 can make phone calls to the number you preferred when the alarm is triggered, you need to add a number to the phone list.

Steps to add phone number:

1. From the GXV3662 home page, click **Basic Settings > SIP**.
2. Go to **Phone List** Tab.
3. Enter the **Phone number** and **name**, click **Add a Number to** save all the changes.
4. Numbers added to the system will be listed in this page.

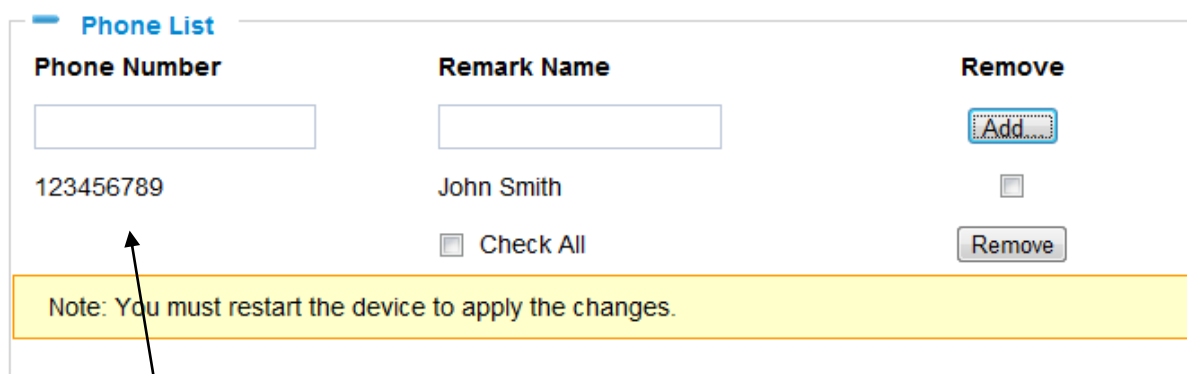

Available phone numbers

NOTE: With current firmware, only the first phone number in the list will be called when an alarm is triggered.

GXV3662 Status Page

System Statistics

System Statistics lists hardware and software information, for example, the part number, the software version, about the GXV3662.

System Statistics

Product Model:	GXV3662
Hardware Version:	V0.2A
Part Number:	9670002002A
Bootloader Version:	1.0.0.0
Core Version:	1.0.1.11
Base Version:	1.0.1.11
Firmware Version:	1.0.1.11
System Up Time Since:	5 hours 1 minute

Hardware Version – This field contains the product’s hardware information.

Part Number – This field contains the product part number information.

Bootloader Version – Bootloader code version number.

Core Version – Core code version number.

Base Version – Base code version number.

Firmware Version – Firmware code version number.

System Up Time Since – This field shows the system up time since the last reboot.

Network Status

Network Status

MAC Address:	00:0B:82:29:5C:C9
LAN IP Address:	192.168.1.37
LAN Subnet Mask:	255.255.255.0
LAN Default Gateway:	192.168.1.1
DDNS Status:	Disabled

MAC Address – The device ID, in HEXADECIMAL format.

LAN IP Address – This field shows the LAN IP address of the GXV3662.

LAN Subnet Mask – This field shows the LAN subnet mask of the GXV3662.

LAN Default Gateway – This field shows the LAN default gateway of the GXV3662.

DDNS Status – This field shows the status of DDNS.

Camera Type

This section shows the Lens information of GXV3662. The Lens type information contains the brand name, the size of image sensor, the resolution and so on.

Camera Type

Camera Type: Aptina, MT9M033 Pixels 1280*960

GXV3662 User Management Page

All current users will be listed in the User List section of this page. You can also add and remove users here.

Existing User Name –The field lists all of the current users. You can insert or remove users from the list by click on the **Add** or **Update** or **Delete** button.

Manage User

Existing User Name: --Add New User-- ▼

User Name:

User Password: ? Add

Confirm User Password: Update

Privilege: Administrator ▼ Delete

Allow Anonymous Viewing: Save

User Name / Password – The user name and password required to login.

Privilege – The privilege for the user to access the configuration page.

Allow Anonymous Login – If ‘Allow Anonymous Login’ is set to Yes, no user name and password are required to login to the GXV3662 web configuration pages. If you login anonymously, you will not be able to change any settings.

GXV3662 Maintenance Page

Server Maintenance

Restart – Click this button to restart the GXV3662.

Restart the device

Restart the device.

Restore – Click this button to perform a partial factory reset (The IP address will not be cleared).

Restore the device

Reset settings, except IP address, to factory default.

Firmware Upgrade and Provisioning Items

Upgrade via – This field lets you choose the firmware upgrade method. The GXV3662 supports HTTP, HTTPS and TFTP.

Firmware Server Path – The IP

Firmware Upgrade and Provisioning

Upgrade via: HTTP ▼

Firmware Server Path:

Automatic Upgrade Interval(Minutes):

Automatic Upgrade:

address or domain name of the firmware server (the location of the firmware files).

Automatic Upgrade Interval – Enter the frequency (in minutes) in which the HTTP/HTTPS/TFTP server will be checked for new firmware upgrades or configuration changes.

Automatic Upgrade – The default setting is “No.” Choose “Yes” to enable automatic HTTP/HTTPS/TFTP upgrade. When set to “No”, the IP Camera will only perform a HTTP/HTTPS/TFTP upgrade and perform a configuration check once during the boot process.

Performing a firmware upgrade:

1. Download the firmware package from <http://www.grandstream.com/firmware.html>.
2. Unzip the firmware package and copy the files to the firmware upgrade server directory.
Upgrades are supported via TFTP, HTTP and HTTPS.
3. Log in to the **Maintenance page** of the GXV3662. Select the server type from the dropdown list under the “Upgrade Via” field. Enter your server’s root directory in the “Firmware Server Path” field.
4. Reboot the GXV3662 to begin the firmware upgrade process.

GXV3662 SMTP Page

The SMTP server is used to send out emails when an alarm event or motion detection is triggered. The SMTP settings must be configured to make sure the alarm email is sent out properly.

SMTP Server Settings

Enable SMTP – Checked to enable SMTP

SMTP Server – The IP or hostname of the SMTP server, for example, smtp.gmail.com.

SMTP Server Port – The port of the SMTP server. The GXV3662 supports port 25 and SSL port 465, which is for SMTP with an encrypted connection.

From E-Mail Address – The email address that sends out the alarm email(s).

To E-Mail Address – The email addresses that the alarm email(s) will be sent to. You can have up to 3 emails configured.

SMTP Server Settings

Enable SMTP:

SMTP Server:

SMTP Server Port:

From E-Mail address:

To E-Mail address 1:

To E-Mail address 2:

To E-Mail address 3:

User Name:

Password:

SSL: ⓘ

¹ Required Fields.

² Valid DNS server is required for hostname.

User Name/ Password – The user name and password required to log in to your SMTP server, for example, 123@gmail.com/123.

SSL – Checked if the SMTP server requires a secure connection.

Test Email Account Settings – Click the Test button to send a test email from the *From E-Mail* to the *To E-Mail* to make sure that SMTP is configured properly. If the receiver can get the test email, then the SMTP settings are ready to go.

GXV3662 FTP Page

The FTP server is used to store video files if you configure the GXV3662 to record video and upload it to the FTP server when an alarm event or motion detection is triggered.

FTP Settings

Enable FTP – The default setting is “No,” if you want the GXV3662 to upload the recorded video to the FTP server when an alarm is triggered, set this field to “Yes.”

FTP Server – The IP address or hostname of the SMTP server, ie. ftp.myserver.com.

FTP Server Port – The port that your FTP server is using.

User Name / Password – The user name and password required to log into your FTP server

Path – The directory in the FTP server where recorded video will be uploaded.

Test FTP Account Settings – Click the Test button to upload a sample file to make sure that FTP is properly configured.

FTP Settings

Enable FTP:

FTP Server:

FTP Server Port:

User Name:

Password:

Path:

Valid DNS server is required for hostname.

GXV3662 Alarm Event

The GXV3662 supports alarm inputs, for example, infrared detector, smoke detector and so on.

Follow the steps to make Alarm Input work:

1. Connect the alarm input equipment to the GXV3662.
2. Set up the alarm event time schedule.
3. Configure the alarm actions which you would like the GXV3662 to take when the alarm is triggered.

How Alarm Input and Alarm Output Work

Alarm-in is the alarm input port; users are able to connect sensors such as infrared sensor

(PIR), smoke sensor or light sensor to it. The detectable signal voltage range for alarm-in is from 1.8V to 15 V **NOTE:** Please do not connect a device that has a signal voltage that is higher than 15V, this will damage the IP camera.

Internally, the Alarm-out uses relays as a switch (30VAC/2A); users can connect devices such as an alarm siren, alert lights or electric strike to this port. Under normal circumstances, the circuit is open. When there is an alarm event, the GXV3662 will close the circuit to trigger the alarm.

Connect Alarm Input Equipment to the GXV3662

Here are two sample connection diagrams. Connect the alarm equipment to the GXV3662 by following the diagram below.

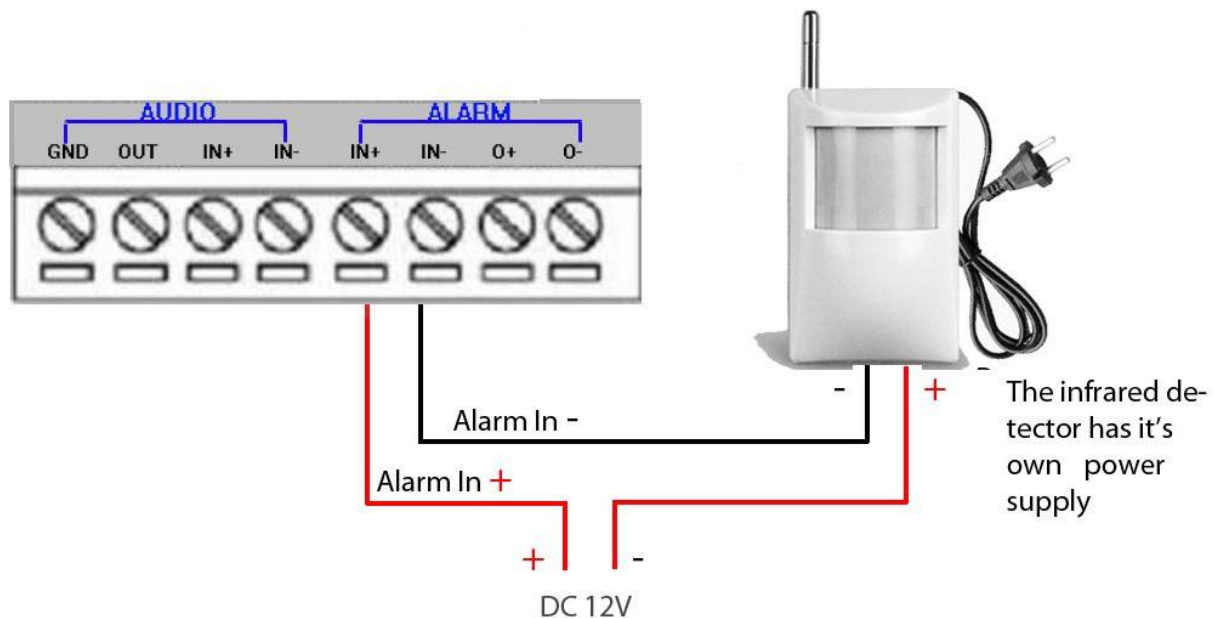
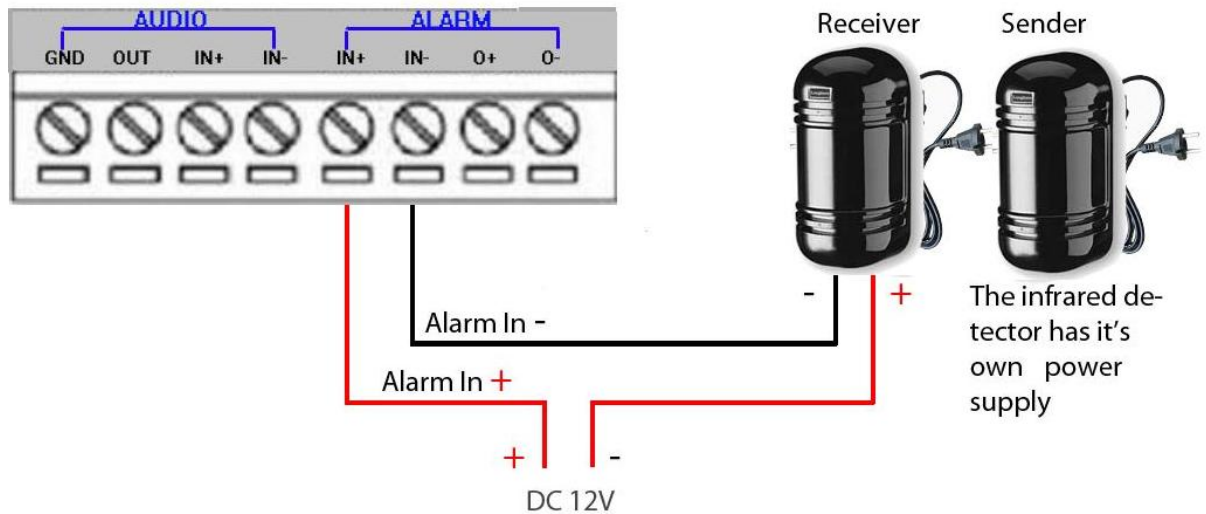

Set up Alarm Actions

An alarm action is what the GXV3662 is going to do when an alarm is triggered during the

defined time period – the time schedule. The GXV3662 allows multiple alarm actions.

Record Video – If this option is selected, the GXV3601 will record the video when an alarm is triggered. You can enter the length of the video recording (in seconds). You can also choose the storage method for video files: SD card, USB Flash drive, or USB hard drive.

Alarm Action

Record Video From Pre Alarm seconds to After Alarm seconds

Voice Alarm to SIP Phone

Alarm Output

Upload to Alarm Center

Email JPEG and Store it to USB card or SD drive

Voice Alarm to SIP Phone – If this option is selected, the GXV3601 will make calls to the number listed in the **Phone List** page using the configured SIP account when an alarm is triggered. To use this function, the settings in **SIP** page must be configured properly.

Alarm Output – If this option is selected, the alarm will output via the configured method/equipment when it is triggered.

Upload to Alarm Center – This option is an integrated feature with GSurf. If this option is checked, the GXV3601 will report the alarm event to GSurf.

Record Video and Upload to FTP server – If this option is selected, the GXV3601 will record the video and upload it to the FTP server when an alarm is triggered. You must check Record Video and configure the FTP page properly to use this feature.

Email JPEG and Store it to USB drive or SD card – If this option is selected, the GXV3601 will capture the image and store it to connected live storage device when an alarm is triggered.

Set up Alarm Event Time Schedule

This section allows you to configure the time during which the GXV3662 will monitor the Alarm Input. The GXV3662 not only can monitor your settings but also can take actions when the alarm is triggered.

Alarm Event Time Schedule

Date	Start Time	End Time	
Tuesday ▼	00:00	23:59	<input type="button" value="Add"/>
Monday	00:00	23:59	<input type="checkbox"/>
Tuesday	00:00	23:59	<input type="checkbox"/>
			<input type="checkbox"/> Check All <input type="button" value="Delete"/>

To add a schedule, select the **date** from the dropdown list, **Start Time** and **End time** and Click **Add** to add a new time schedule.

To delete a schedule, check the schedule you would like to remove and click **Delete**.

How to connect an Alarm Output Equipment to GXV3662

Here is a sample connection diagram. Connect the alarm output equipment to the GXV3662 by following the diagram below.

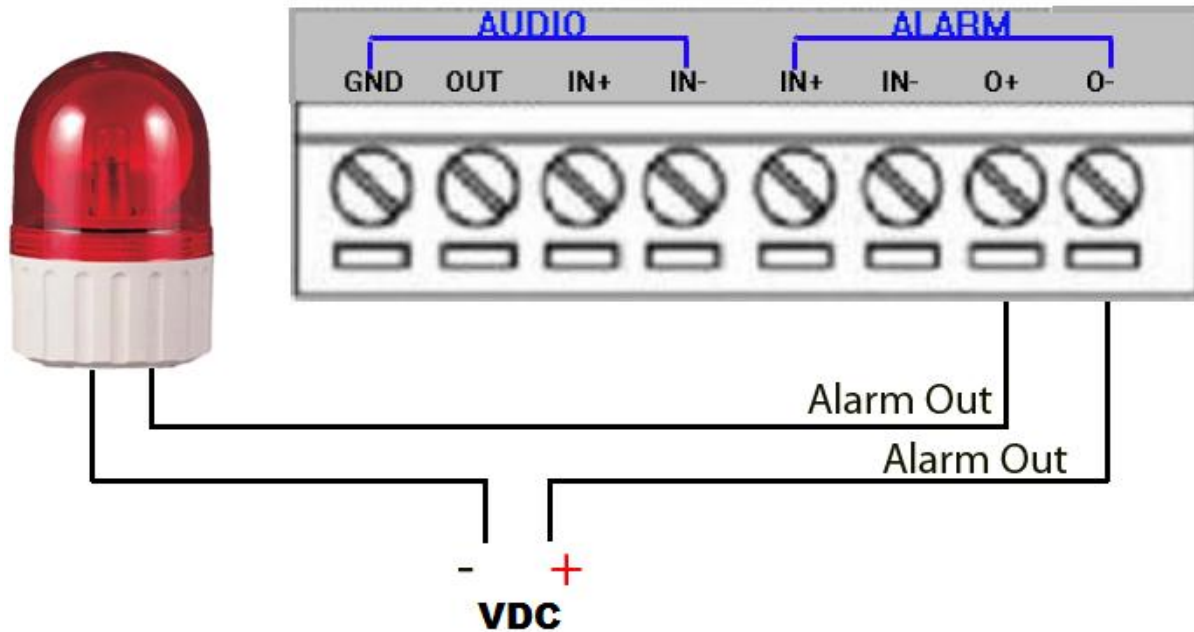

GXV3662 Motion Detection Page

The GXV3601 supports Motion Detection. To utilize this feature, please follow the steps below:

1. Setup the motion detection monitored area.
2. Configure the motion detection time schedule.
3. Configure alarm action properly.

Setup Motion Detection Monitored Area

Enable Motion Detection – If this option is selected, motion detection will be enabled. If something/somebody moves in the motion detection region, an alarm will be triggered.

Show Motion Detection Regions – If this option is selected, the motion detection regions will be displayed on the screen with a white border.



The white border for Motion Detection Regions

NOTE: If **Upload to Alarm center** is checked for **Alarm Actions**, the white border will **flash red** when a motion detection alarm is triggered.

To Edit a Monitored Area

1. In the **Select a Region** dropdown list, select the region ID.
2. Click **Edit**.
3. Click on the video, drag and draw you preferred area.
4. Set the Sensitivity. Click the **Save** button to save the sensitivity.

NOTE: The Sensitivity value varies from 0 to 100. The larger the value is, the higher the sensitivity.

5. Click **Save** to save the settings.

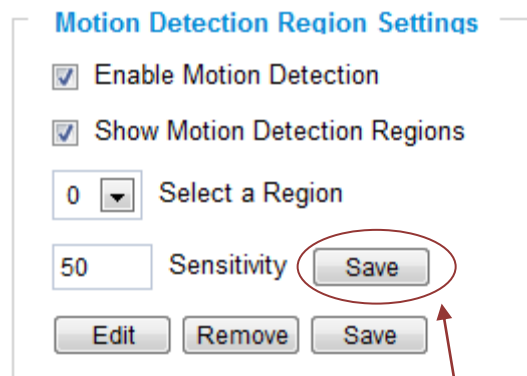

Button to save sensitivity only

To Remove a Monitored Area

1. In the **Select a Region** dropdown list, select the region you would like to remove.
2. Click **Remove**.
3. Click **Save** to save the changes.

Configure Motion Detection & Alarm Actions

An alarm action is what the GXV3662 is going to do when an alarm is triggered during the defined time period – the time schedule. The GXV3662 allows multiple alarm actions.

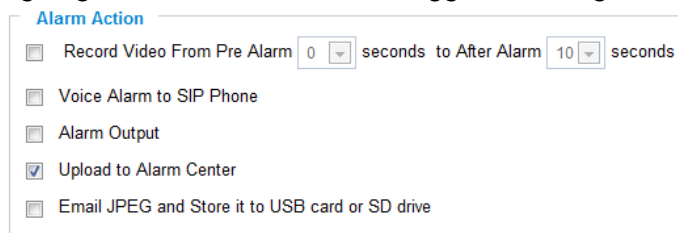

Configure Motion Detection Time Schedule

This section allows you to configure the time during which the GXV3662 will monitor the motion detection. The GXV3662 not only can monitor your settings but also can take actions when the alarm is triggered.

Monitored region Dropdown list for date Available time schedules

Region ID	Date	Start Time	End Time	
3	Thursday	00:00	23:59	<input type="button" value="Add"/>
0	Monday	00:00	23:59	<input type="checkbox"/>
1	Tuesday	00:00	23:59	<input type="checkbox"/>
3	Thursday	00:00	23:59	<input type="checkbox"/>
				<input type="checkbox"/> Check All <input type="button" value="Delete"/>

GXV3662 System Log

This page is used to set up the system log server path and system log level. Once they are correctly configured, the device will send out system log messages to the system log server, which will help perform troubleshooting.

Syslog Server – The IP address or URL of System log server.

Syslog Level – Select the device to report the log level. Default is None. The level is one of Debug, Info, Warning or Error.

SystemLog Settings

Syslog Server:

Syslog Level:

- None
- Debug
- Info
- Warning
- Error

GXV3662 Live Storage

This page displays detailed information of the live storage devices connected to the GXV3662 such as video and image files. You can view, download or delete the stored files.

Storage Information – This section displays the type, capacity, used space, free space and usage percentage of the connected SD card.

Storage Information					
Type	Capacity	Used Space	Free Space	Use(%)	Umount
USB	7.5G	2.3M	7.5G	0.03%	<input type="button" value="Umount"/>

JPEG List – This section displays the name, source storage and size of the image files on the connected storage devices. You can view, download or delete the stored files.

JPEG List			
File Name	Size	View	Check
192.168.40.191_chn1_2010_09_16_07_32_16.jpg	87.1k		<input type="checkbox"/>
Pages:1 Total:1 Index:1-1 Goto: <input type="text" value="1"/> Page		<input type="checkbox"/> Check All	<input type="button" value="Delete"/>

Video List – This section displays the name, source storage and size of the video files on the connected storage devices. You can view, download or delete the stored files.

Video List			
File Name	Size	Download	Check
192.168.40.191_chn1_2010_09_16_07_31_38_1_15.avi	2.1M		<input type="checkbox"/>
Pages:1 Total:1 Index:1-1 Goto: <input type="text" value="1"/> Page		<input type="checkbox"/> Check All	<input type="button" value="Delete"/>

IP VIDEO SURVEILLANCE FAQ

1. What is the default IP address of the GXV-3662?

The default IP configuration is DHCP.

2. Why can I not view the live video stream in Microsoft Internet Explorer?

Please check whether the IE add-on is installed correctly.

Once you log into the GXV 3662 web interface, Internet Explorer will indicate that “This website wants to install to following add-on: ‘GSViewer. cab’ from Grandstream Networks, Inc.”. Please install this add-on when prompted by IE.

3. How do you manually uninstall the Grandstream video viewer add-on for IE?

Please follow these steps to uninstall the add-on:

1. Delete the *GSViewerX Control* from *C:\WINDOWS\Downloaded Program Files* directory
2. Delete *GSNetClient.dll*, *GS_Replay.exe*, *GSViewerX.ocx*, *hi_h264dec_w.dll*, *lik_VoiceEngine_dll.dll* and *GSViewerX.inf* from *C:\WINDOWS\system32*

4. Why can't I access the GXV-3662 web configuration interface?

Q 1: Is your internet service down?

A 1: Connect a PC to the internet to test the connection.

Q 2: Are the PC and the device in different subnets?

A 2: Check the subnet mask and default gateway of the device and PC.

Q 3: Is there a conflict with another IP address?

A 3: Try to change the IP address of the device.

Q 4: Has the HTTP port been changed?

A 4: Contact the administrator of the device for more information.

5. The GXV-3662 web configuration page is not displayed correctly in Internet Explorer 8?

In IE8, Compatibility View might need to be enabled for the GXV-3662 web configuration page to load properly. To enable compatibility view, open IE8, click *Tools, Compatibility View Setting*, and add the GXV-3662 web configuration pages to the Compatibility View.

6. Why does IE indicate to install Grandstream Video Viewer add-on after a firmware upgrade? The add-on was properly installed before the firmware upgrade process.

New firmware will often upgrade the add-on as well. To watch the live video stream, you must install the newest version of the add-on.

7. How do you watch secondary video stream?

Login to the home page of the GXV-3662 web GUI, click Play to watch the video stream. To watch a secondary video stream, right click on the video, and select *Secondary Stream* on the pop-up menu. Try reinstalling the Grandstream Viewer add-on for IE if you cannot see the video stream.

8. Why is audio missing from the recorded video when an alarm is triggered?

Please double check whether the device has an audio input connected.

GXV3662 has a MIC IN port for an audio input.

9. What is DDNS? Is it important for IP surveillance product to have DDNS support?

DDNS is an acronym for Dynamic Domain Name Service. It is important to choose an IP network camera that has DDNS support for dynamic IP addresses.

Chances are that the network has a dynamic IP address (which changes with every log on). A DDNS service makes sure that the camera's IP address always matches up to the current server address. DDNS also allows for a website to be linked to the IP camera that is constantly updated with the correct information and has a reliable feed.

10. Why is Windows Media Player unable to play the recorded videos files?

The GXV-3662 uses the H.264 video codec. Windows Media Player may lack the proper H.264 decoder to play the recorded video. Please download the Microsoft FFDSHOW H.264 decoder from <http://sourceforge.net/projects/ffdshow-tryout/> and install it.

11. Alarm Triggered Events do not work in GSurf.

Please double check the Alarm Action on your GXV-3662. Login to the web GUI of the GXV3662, go to the *Motion Detection* or *Alarm Events* page, and make sure option *Upload to Alarm Center* is checked.

12. It is recommended that you save your video files in different directories when using GSurf and GS_NVR.

GSurf and GS_NVR are different programs that have the ability to delete recorded video files. It is better to save video files in different directories when using GSurf and GS_NVR in the event that they automatically delete files that you might want to keep.

13. How can I use a cell phone to watch the GXV3662 video stream?

You must set the video resolution to QCIF to watch the GXV3662 video stream from a cell phone. Make sure to set the bit rate to 64kbps to ensure the best video quality.

14. Why doesn't the IP address of the device reset when I click the "Restore" button on the Maintenance page?

The GXV3662 could be installed in areas that are not easy to access. For example, it could be installed on the roof of a building or the ceiling of an office. This makes it difficult to reinstall the device, therefore the "Restore" function will not clear the IP address. Press the RESET button on the device for at least 6 seconds until you hear a beep to perform a factory reset of all parameters (including the IP address).

15. Why can't the live video stream be viewed using a mobile phone or GSurf after changing the HTTP Port of the device?

Make sure that the RTSP port of the device is set to 2000 plus the HTTP Port number. For example, if the HTTP port is 88, then the RTSP port of the device that you configured on GSurf / mobile phone should be 2088.

16. Some notes on using SD cards

1. The GXV3662 only supports FAT32 formatted SD cards
2. The GXV3662 supports SD and SDHC
3. It takes 10-15 seconds to read SDHC cards with large memory capacities. Please wait 15 seconds to unplug the SD card after you plug them into the device.
4. If there are many files (ie. 1800 or more image batch files) on the SD card, it can take up to 5 minutes to read them. Please do not refresh the web interface at this time as the GXV3662 will restart reading the SD card. Grandstream is currently working on a fix for this issue.

17. Port forwarding

Two ports must be forwarded on your router to watch video from a GXV3662 that is located on a private network from a PC in a public network. The web port (HTTP) and the RTSP port. Please make note that the RTSP port number changes according to the web port. If the web port is 80, then the RTSP port is 554. If the web port is not 80, then the RTSP port equals the web port +2000. For example, if the web port is 88, then the RTSP port will be 2088.

18. Tested PC display adapters.

Display Adapter	Test Result
SiS 650/651/740/661 FX/741/760 Series	Works normally
Intel(R) 82945R Express Chipset Family	Works normally
VIA/S3G UniChrome Pro IGP	Works normally
NVIDIA Geforce 7300GS	Works normally
SiS 661FX	Works normally
SiS Mirage Graphics	Works normally
SiS 661 Series	Works normally
Intel(R) G33/G31 Express	Works normally
SiS Mirage3 Graphics	Works normally
SiS 661FX/GX Mirage Graphics	Works normally
S3 Graphics ProSavageDDR(Microsoft Corporation)	Works normally
XGI Velari Z7/Z9/Z9S V1.08.12	There is some delay when playing videos.
Intel 965 Express Chipset Family	Works normally
ATI Mobility Radeon X1300	Works normally
Intel(R) G45/G43 Express Chipset	Works normally
Mobile Intel 965 Express Chipset Family	Works normally
Mobile Intel(R) 4 Series Express Chipset Family	Works normally
Mobile Intel® 945GM Express Chipset Family	Works normally
Mobile intel® 915GM/GMS, 910GML Express Chipset	Works normally

Family	
Intel® G45/G43 Express Chipset	Works normally
ATI Technologies, RAGE XL PCI	This display adapter cannot display videos.